

## SAUROLOPHUS with Lokus

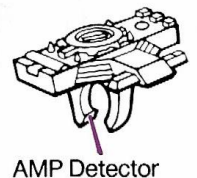
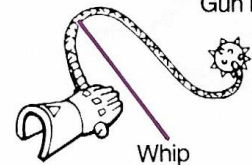
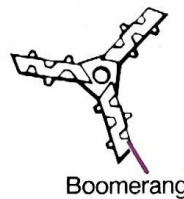
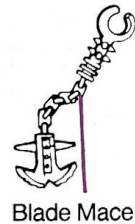
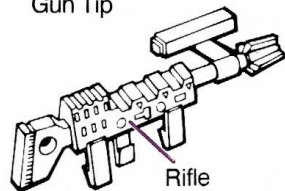
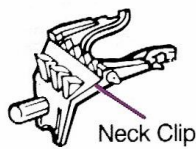
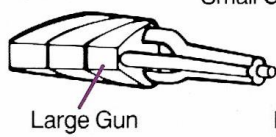
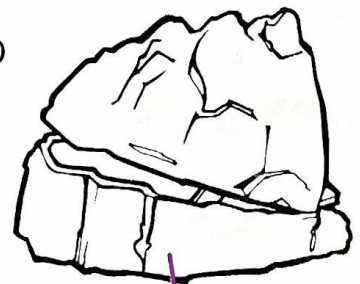
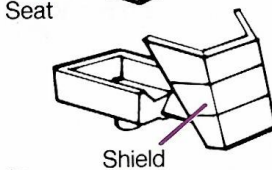
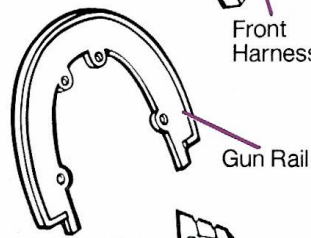
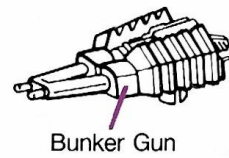
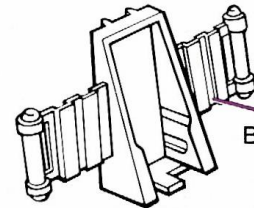
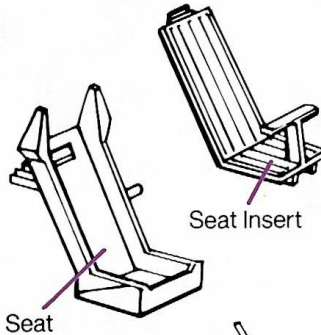
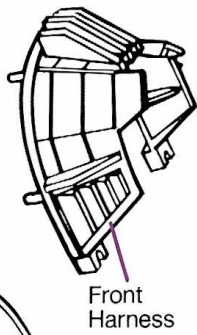
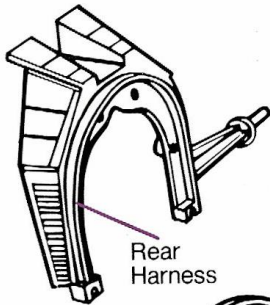
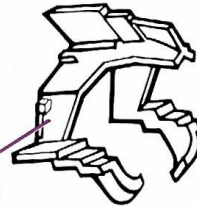
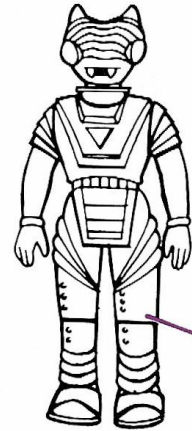
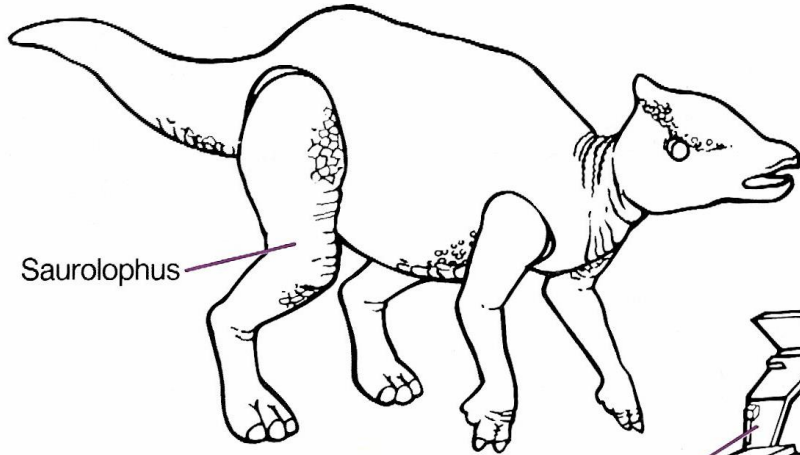

Accessories may or may not be attached to the parts tree.

1

Push the Slider on to the Gun Rail, The Belly Blade to the Belly Harness.

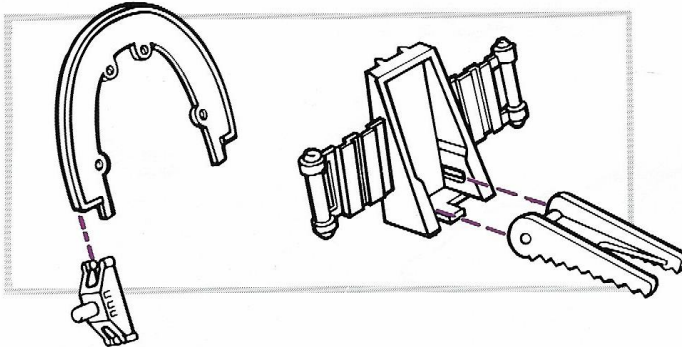

2

Assemble the Front Harness trapping the Gun Rail. Then hook one side of the Front Harness to the Front and Rear Harness.

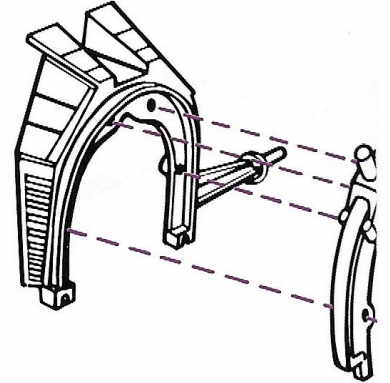

4

Mount the Large and Small Gun Tips to the Large and Small Guns. Mount the Large Gun to the Slider and the Small Gun to the Seat.

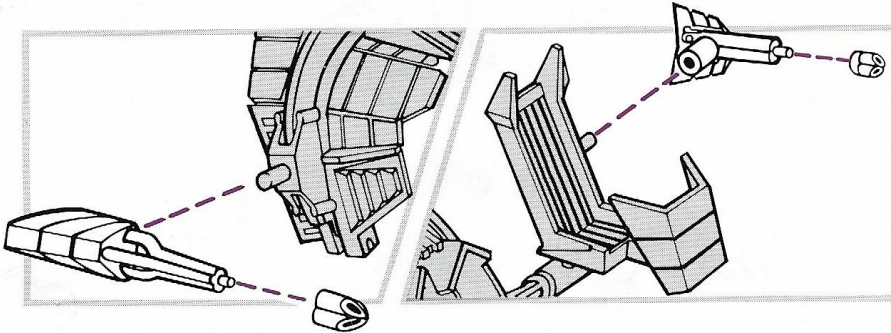

5

Fit the entire harness assembly onto the Saurolophus.

6

Saurolophus normally strides on four legs with the Large Gun positioned at the top of the harness. When threatened, he rears up on his hind legs like a grizzly bear. Slide the Large Gun to the side position, fold open the deadly Belly Blade and turn the seat to face forward. Note: To make saurolophus rear up, hold one rear foot to the floor and press down on the tail as illustrated.

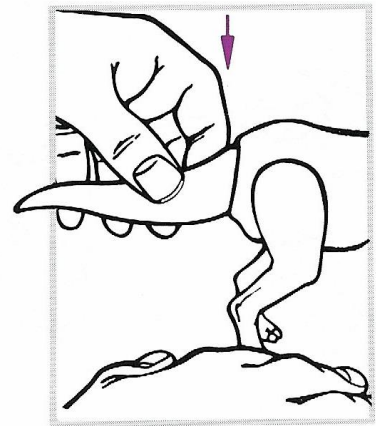
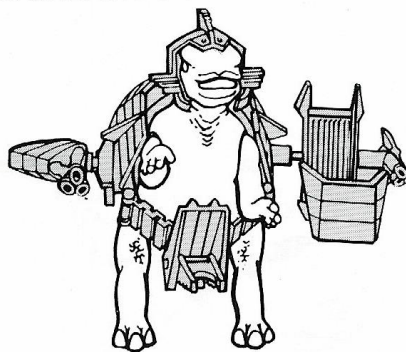
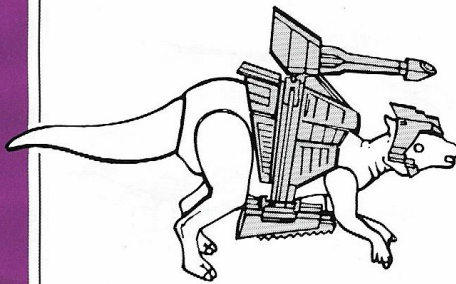



ness and the Rear  
un Rail as shown.  
he Belly Harness  
arness assembly.

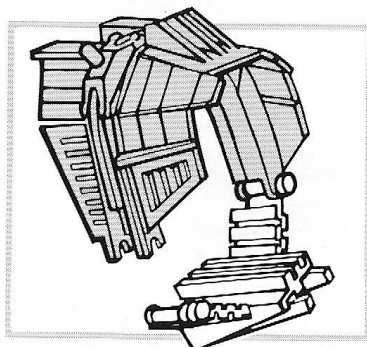

3

Fit the Seat Insert into  
the Seat. Then  
mount the Seat, Shield  
and Swivel to the  
Harness.

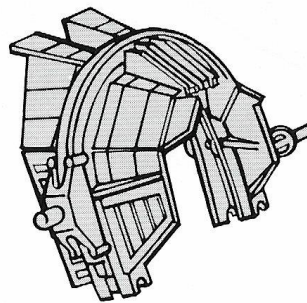
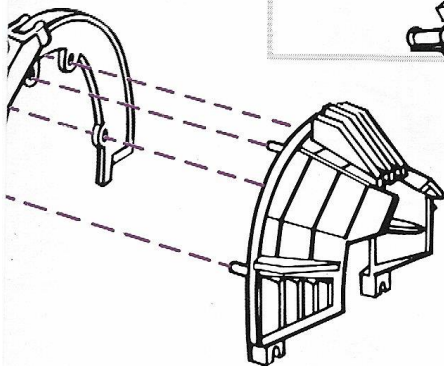
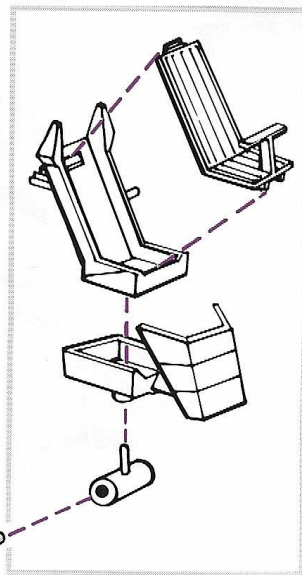

the assembly to Saurolophus and hook the  
side of the Belly Harness to the Front/Rear  
assembly. Fit the Brain Box.

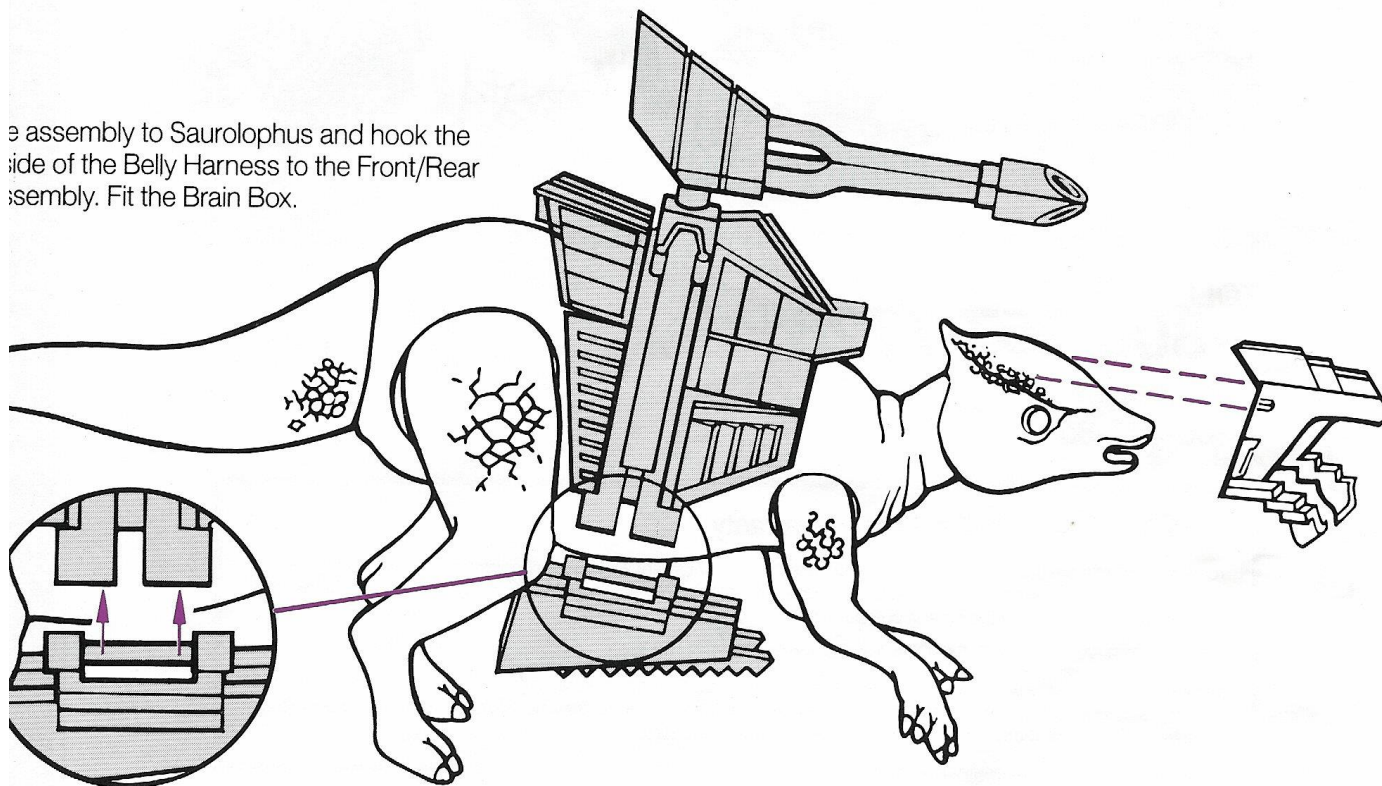



7

Lift open the Rock Bunker and mount the Bunker Gun Tip on the Bunker Gun. Lokus sits in the seat. Then cock the Gun/Seat by pushing it straight back. Close the rock, wait for the right moment for an ambush, and press the trigger!

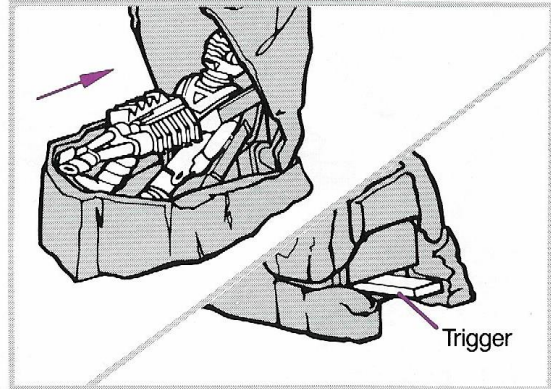
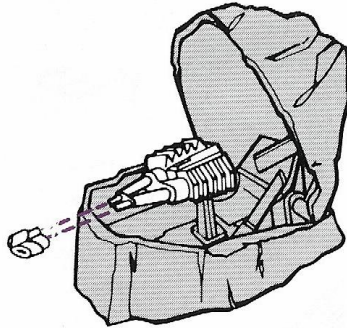

8

Fit the neck clip to Lokus. This enables him to carry either the Boomerang or the Rifle as shown. The Rifle, Whip, Blade Mace and AMP Detector clip on to his arm.

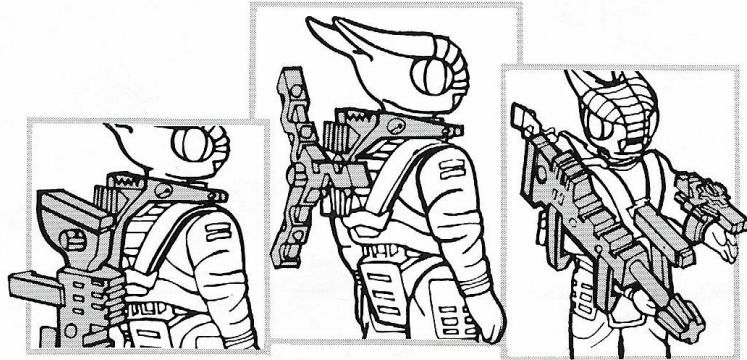

If you have any comments or questions about your Tyco Dino-Rider playsets, please call us.

**TOLL FREE**  
**1-800-257-7728**

**IN NEW JERSEY**  
**1-800-322-8011**

#### Tyco Dino-Riders 90 Day Limited Warranty

All Tyco products are thoroughly inspected and tested before shipment and guaranteed to be free from factory defects in materials or workmanship. If you find a defective part in your set — within 90 days of purchase mail the product along with proof of the date of purchase to:

TYCO SUPER-FAST SERVICE, 540 Glen Avenue, Moorestown, NJ 08057

We will repair or provide a replacement part or unit without charge. To prevent damage in transit, please pack securely. This warranty does not cover damage resulting from accident, misuse or abuse. This warranty gives you specific legal rights and you may also have other rights which vary from state to state.

Tyco Industries, Inc.  
Moorestown, NJ 08057

**TYCO**<sup>®</sup>

PRINTED IN HONG KONG  
© 1989 97-8-148